

STATE CATCH BASIN 8" WALL SUMP

DESIGN COMFORMS TO CDOT
AND LOCAL SPECIFICATIONS.

NOTES:

1. REINFORCING STEEL WELDED WIRE FABRIC CONFORMS TO LATEST ASTM SPECIFICATION A185.
2. REINFORCING STEEL DEFORMED BARS CONFORM TO LATEST ASTM SPECIFICATION A615.
3. CONCRETE COMPRESSIVE STRENGTH- 4000 PSI AT 28 DAYS.
4. METHOD OF MANUFACTURE: WET CAST.
5. SECTION IS MONOLITHIC.
6. DESIGN LOAD: AASHTO H-20

WEIGHT CHART

PRODUCT	APPROX WEIGHT
8" WALL SUMP	4750 LBS.

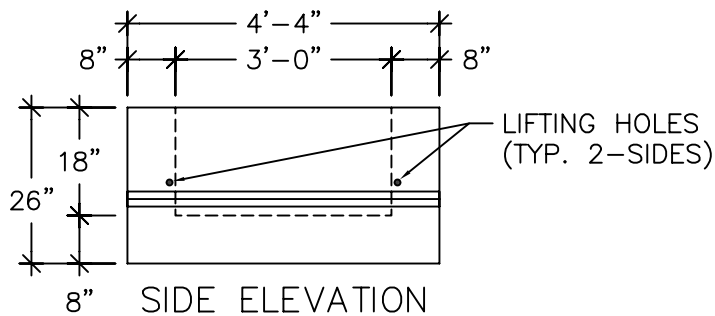
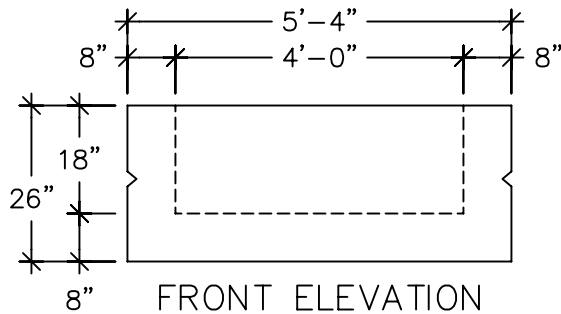
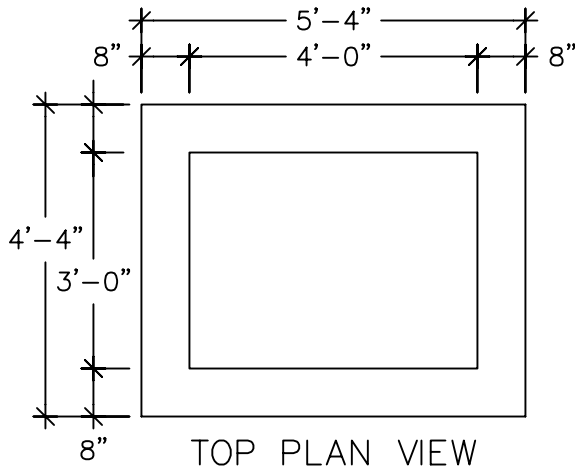

UNITED CONCRETE PRODUCTS INC.

173 CHURCH STREET
YALESVILLE, CT 06492

TEL. 800 234-3119
(203) 269-3119

FAX. (203) 265-4941